

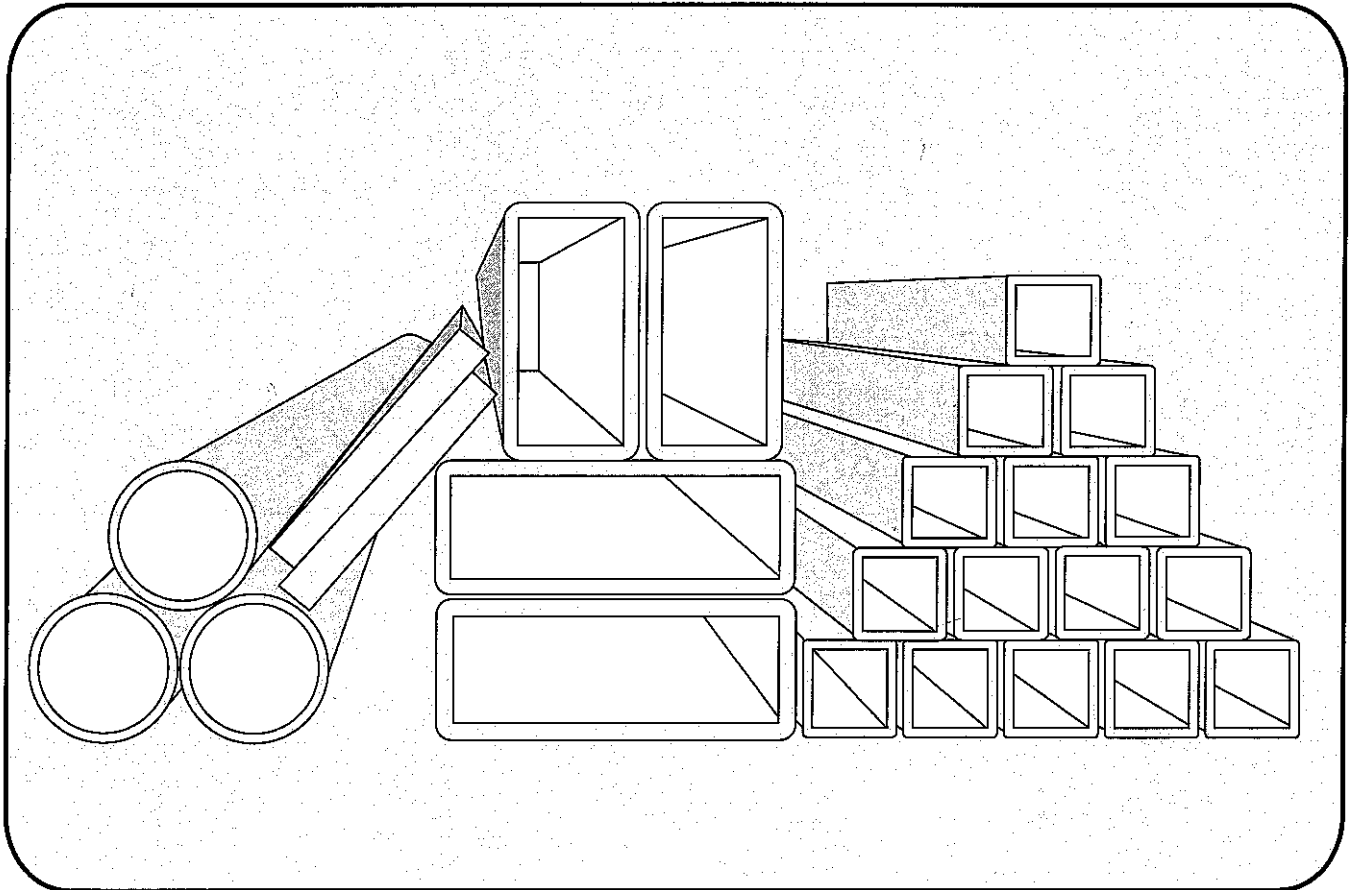

AFCO Industries, Inc.

3400 Roy Street • Alexandria, LA 71307
Phone: (318) 448-1651 • Fax: (318) 443-9288
Out of State Call 1-800-551-6576



STANDARD SHAPES CATALOG



AFCO Industries, Inc.
3400 Roy Street
P.O. Box 5085
Alexandria, LA 71302-5085
Phone No.: 318-448-1651
Toll Free: 800-551-6576
Fax No.: 318-443-9288
Website: www.afco-ind.com

Table of Contents

<i>Description</i>	<i>Page</i>
Square and Rectangular Tubes.....	1-2
Square and Rectangular Bars.....	3-4
Round Rods.....	5
Round Tubes.....	6-7
Schedule Pipe.....	8
Architectural Angles.....	9-10
Architectural Channels.....	11-12
Structural Angles.....	13
T Sections.....	14
H or I-Beam.....	15
Z Bars.....	16
Extrusion Standard Tolerance Tables.....	17-18



3400 Roy Street
 P.O. Box 5085
 Alexandria, LA 70302
 Phone: 800.551.6576
 Fax: 318.443.9288
 www.afco-ind.com

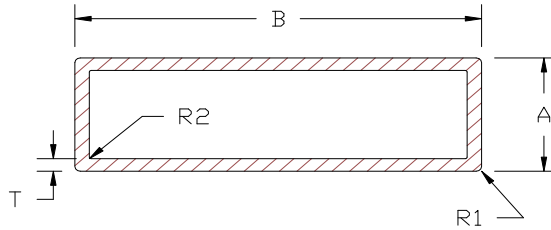

SQUARE & RECTANGULAR TUBES

No.	Die Number	A	B	T	R1	R2	Wt/Ft.	Perimeter	Special Notes
1	AF-1280	0.375	0.480	0.050	0.025	0.015	0.091	2.951	
2	AF-3621	0.472	1.313	0.125	0.010	0.030	0.462	6.071	
3	AF-0905	0.500	0.500	0.050	0.031	0.015	0.107	3.521	
4	AF-0793	0.500	0.500	0.062	0.031	0.015	0.130	3.425	
5	AF-3089	0.500	0.500	0.080	0.062	0.031	0.174	3.201	
6	AF-2104	0.500	1.000	0.120	0.080	0.060	0.362	4.868	
7	AF-0866	0.500	1.000	0.125	0.062	0.010	0.372	4.877	
8	AF-4877	0.500	1.500	0.125	0.010	0.010	0.524	6.977	
9	AF-2316	0.625	0.625	0.125	0.120	0.020	0.286	3.760	
10	AF-0729	0.750	0.750	0.050	0.015	0.010	0.168	5.557	
11	AF-4734	0.750	0.750	0.050	0.031	0.010	0.167	5.557	
12	AF-0526	0.750	0.750	0.062	0.015	0.015	0.235	5.452	
13	AF-0780	0.750	0.750	0.075	0.005	0.020	0.244	5.357	
14	AF-3088	0.750	0.750	0.080	0.062	0.031	0.280	5.201	
15	AF-0867	0.750	0.750	0.125	0.062	0.015	0.371	4.868	
16	AF-1518	0.750	1.000	0.055	0.010	0.010	0.217	6.886	
17	AF-0802	0.750	1.500	0.084	0.250	0.156	0.381	7.631	
18	AF-3255	0.875	0.875	0.055	0.125	0.070	0.205	6.225	
19	AF-3130	0.985	0.985	0.055	0.065	0.010	0.253	7.311	
20	AF-0772	1.000	1.000	0.050	0.062	0.060	0.228	7.391	
21	AF-1453	1.000	1.000	0.062	0.062	0.038	0.303	7.344	
22	AF-5009	1.000	1.000	0.062	0.188	0.126	0.259	6.965	
23	AF-0794	1.000	1.000	0.075	0.062	0.031	0.335	7.290	
24	AF-2768	1.000	1.000	0.125	0.010	0.010	0.525	6.966	
25	AF-0868	1.000	1.000	0.125	0.062	0.010	0.512	6.901	
26	AF-2493	1.000	1.000	0.125	0.160	0.010	0.499	6.708	
27	AF-4849	1.000	1.375	0.073	0.094	0.015	0.390	8.876	
28	AF-2755	1.000	1.500	0.050	0.010	0.010	0.288	9.566	
29	AF-4847	1.000	2.000	0.073	0.094	0.015	0.490	11.231	
30	AF-0289	1.000	2.000	0.125	0.030	0.016	0.824	10.922	
31	AF-4848	1.000	3.000	0.125	0.091	0.015	1.126	14.960	
32	AF-3424	1.000	4.000	0.125	0.060	0.010	1.422	18.880	
33	AF-3254	1.085	1.085	0.093	0.063	0.010	0.439	7.813	
34	AF-4690	1.236	1.498	0.080	0.250	0.170	0.460	9.564	
35	AF-1523	1.250	1.250	0.062	0.125	0.062	0.341	9.183	
36	AF-4946	1.250	1.250	0.090	0.125	0.062	0.488	8.959	
37	AF-0869	1.250	1.250	0.125	0.062	0.010	0.671	8.877	
38	AF-4700	1.357	1.357	0.062	0.010	0.010	0.385	10.337	
39	AF-5041	1.375	1.375	0.120	0.060	0.060	0.724	9.834	
40	AF-2381	1.400	3.150	0.075	0.010	0.010	0.785	17.406	



3400 Roy Street
 P.O. Box 5085
 Alexandria, LA 70302
 Phone: 800.551.6576
 Fax: 318.443.9288
 www.afco-ind.com

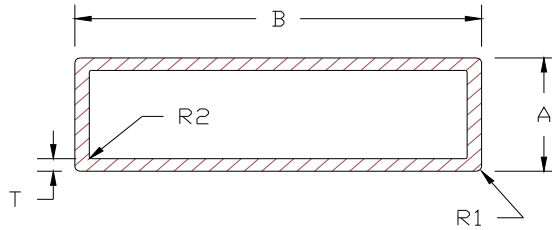

SQUARE & RECTANGULAR TUBES

No.	Die Number	A	B	T	R1	R2	Wt/Ft.	Perimeter	Special Notes
41	AF-0395	1.500	1.500	0.050	0.031	0.010	0.347	11.530	
42	AF-3583	1.500	1.500	0.065	0.010	0.010	0.448	11.480	
43	AF-4648	1.500	1.500	0.100	0.188	0.093	0.644	10.718	
44	AF-4334	1.500	1.500	0.250	0.010	0.010	1.500	9.966	
45	AF-0779	1.500	2.000	0.125	0.005	0.005	0.796	12.982	
46	AF-4194	1.512	3.012	0.125	0.125	0.031	1.268	16.828	
47	AF-3575	1.523	3.438	0.100	0.010	0.010	1.144	19.012	
48	AF-2812	1.625	1.625	0.125	0.010	0.062	0.931	11.905	
49	AF-3571	1.688	3.688	0.125	0.156	0.125	1.529	20.021	
50	AF-5042	1.705	1.705	0.110	0.060	0.060	0.842	12.554	
51	AF-4592	1.750	1.750	0.125	0.031	0.016	0.974	12.936	
52	AF-3522	1.763	3.763	0.100	0.010	0.010	1.278	21.390	
53	AF-4686	1.875	1.875	0.125	0.125	0.045	1.036	13.708	
54	AF-4835	1.970	3.160	0.098	0.015	0.044	1.157	19.648	
55	AF-0257	2.000	2.000	0.125	0.015	0.015	1.126	14.948	
56	AF-4426	2.000	2.000	0.188	0.406	0.218	1.515	13.425	
57	AF-3286	2.000	3.000	0.125	SC	SC	1.468	19.011	
58	AF-3483	2.000	4.000	0.125	0.188	0.110	1.702	22.489	
59	AF-3572	2.000	4.000	0.125	0.250	0.125	1.676	22.356	
60	AF-4029	2.000	5.000	0.125	0.010	0.010	2.030	27.000	
61	AF-2719	2.500	6.000	0.125	0.010	0.010	2.549	32.977	
62	AF-4650	2.562	2.562	0.250	0.093	0.010	2.766	18.323	
63	AF-2125	2.938	5.875	0.125	0.062	0.015	2.566	34.118	
64	AF-2138	2.938	5.875	0.187	0.062	0.015	3.897	33.624	
65	AF-3125	3.000	3.000	0.075	0.031	0.015	1.052	23.333	
66	AF-4685	3.000	3.000	0.080	0.250	0.170	1.086	22.639	
67	AF-1436	3.000	3.000	0.090	0.031	0.015	1.256	23.201	
68	AF-4723	3.000	3.000	0.125	0.031	0.010	1.724	22.929	
69	AF-0984	3.000	4.000	0.125	0.062	0.125	2.037	26.679	
70	AF-3798	3.490	3.490	0.075	0.125	0.063	1.306	13.745	
71	AF-3711	3.500	3.500	0.125	0.125	0.010	2.010	26.768	
72	AF-4579	3.650	3.650	0.090	0.200	0.120	1.802	28.805	
73	AF-1111	4.000	4.000	0.125	0.125	0.062	2.383	30.679	
74									
75									
76									
77									
78									
79									
80									



3400 Roy Street
 P.O. Box 5085
 Alexandria, LA 70302
 Phone: 800.551.6576
 Fax: 318.443.9288
 www.afco-ind.com

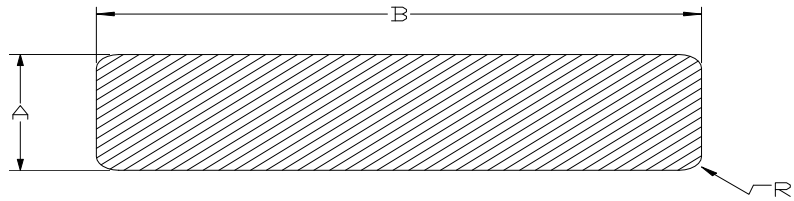

SQUARE & RECTANGULAR BARS

No.	Die Number	A	B	R		Wt/Ft	Perimeter	Special Notes
1	AF-2242	0.062	0.750	0.010		0.056	1.624	
2	AF-2239	0.062	1.000	0.010		0.074	2.124	
3	AF-2943	0.062	4.000	0.010		0.307	8.125	
4	AF-2581	0.063	0.500	0.010		0.039	1.125	
5	AF-2735	0.063	0.750	0.010		0.058	1.625	
6	AF-2717	0.063	1.250	0.010		0.097	2.625	
7	AF-2716	0.063	1.500	0.010		0.116	3.125	
8	AF-2609	0.063	2.000	0.010		0.150	4.125	
9	AF-4900	0.080	1.250	0.030		0.112	2.608	
10	AF-3241	0.083	0.750	0.010		0.077	1.667	
11	AF-2189	0.100	1.125	.062/.015		0.137	2.384	
12	AF-2188	0.110	0.950	0.015		0.129	2.094	
13	AF-2406	0.125	0.500	0.010		0.075	1.250	
14	AF-2942	0.125	0.625	0.010		0.094	1.500	
15	AF-0188	0.125	0.750	0.010		0.113	1.733	
16	AF-0187	0.125	1.000	0.015		0.150	2.225	
17	AF-3543	0.125	1.000	F.R.		0.146	2.143	
18	AF-1171	0.125	1.500	0.010		0.225	3.250	
19	AF-3390	0.125	1.562	0.010		0.234	3.375	
20	AF-4758	0.125	1.750	0.010		0.263	3.750	
21	AF-1205	0.125	2.000	0.010		0.300	4.233	
22	AF-4722	0.125	3.000	0.063		0.446	6.143	
23	AF-2193	0.156	0.380	SC		0.073	1.072	
24	AF-3243	0.175	2.000	F.R.		0.412	4.200	
25	AF-0354	0.187	1.500	0.020		0.336	3.340	
26	AF-3109	0.200	0.900	.100/.010		0.211	2.114	
27	AF-1170	0.250	1.000	0.010		0.300	2.483	
28	AF-3544	0.250	1.000	F.R.		0.285	2.285	
29	AF-1469	0.250	1.500	0.010		0.450	3.483	
30	AF-5337	0.250	2.000	0.010		0.600	4.500	
31	AF-2570	0.250	3.000	SC		0.927	6.500	
32	AF-3692	0.250	3.625	0.010		1.087	7.733	
33	AF-2571	0.250	4.000	SC		1.236	8.500	
34	AF-3811	0.250	5.000	0.010		1.500	10.500	
35	AF-0973	0.250	6.000	0.015		1.800	12.474	
36	AF-4706	0.275	2.000	F.R.		0.641	4.314	
37	AF-3271	0.305	2.000	F.R.		0.729	4.348	
38	AF-4788	0.313	3.375	0.010		1.266	7.358	
39	AF-5104	0.313	3.500	0.010		1.313	7.608	
40	AF-4727	0.313	4.500	0.010		1.687	9.608	
41	AF-4596	0.313	5.000	0.010		1.874	10.608	
42	AF-4781	0.313	5.500	0.010		2.063	11.608	



3400 Roy Street
 P.O. Box 5085
 Alexandria, LA 70302
 Phone: 800.551.6576
 Fax: 318.443.9288
 www.afco-ind.com

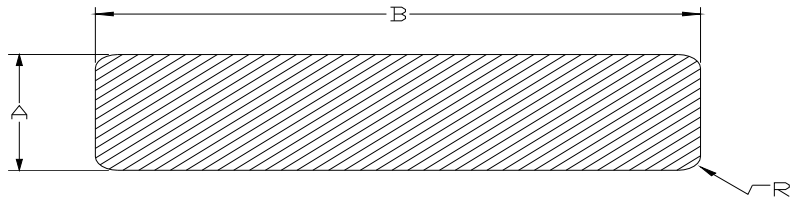

SQUARE & RECTANGULAR BARS

No.	Die Number	A	B	R		Wt/Ft	Perimeter	Special Notes
43	AF-4851	0.375	1.000	0.015		0.450	2.724	
44	AF-4423	0.375	1.500	0.010		0.676	3.750	
45	AF-3487	0.375	2.000	0.010		0.900	4.750	
46	AF-4640	0.375	2.000	F.R.		0.864	4.428	
47	AF-5316	0.375	4.000	0.010		1.800	8.733	
48	AF-5004	0.375	6.000	0.010		2.700	12.733	
49	AF-3329	0.380	2.000	0.010		1.003	4.743	
50	AF-1932	0.438	2.000	F.R.		1.083	4.502	
51	AF-2318	0.500	0.500	SC		0.300	2.000	
52	AF-3111	0.500	1.000	0.060		0.695	2.897	
53	AF-4422	0.500	3.000	0.010		1.800	7.000	
54	AF-0461	0.500	4.000	0.015		2.400	8.974	
55	AF-5313	0.500	4.500	0.010		2.700	9.983	
56	AF-3932	0.500	6.000	0.063		3.597	12.892	
57	AF-3482	0.625	2.000	0.125		1.529	5.035	
58	AF-2137	0.750	0.750	0.010		0.695	3.000	
59	AF-3553	0.750	1.000	0.125		0.884	3.285	
60	AF-4632	0.750	1.750	0.010		1.574	4.986	
61	AF-5117	0.750	3.000	0.010		2.700	7.483	
62	AF-3481	1.000	1.000	0.125		1.220	3.785	
63	AF-4606	1.000	2.000	0.010		2.400	5.983	
64	AF-4626	1.000	2.625	0.015		3.150	7.224	
65	AF-4607	1.000	3.000	0.010		3.6	7.983	
66	AF-3021	1.000	6.000	0.010		7.200	14.000	
67	AF-3707	1.102	3.346	F.R.		4.113	7.950	
68	AF-3592	1.440	1.750	1.750		2.714	5.371	
69	AF-3020	1.500	4.000	0.010		7.200	11.000	
70								
71								
72								
73								
74								
75								
76								
77								
78								
79								
80								
81								
82								
83								
84								

*SC = Sharp Corners, F.R. = Full Radius



3400 Roy Street
 P.O. Box 5085
 Alexandria, LA 70302
 Phone: 800.551.6576
 Fax: 318.443.9288
 www.afco-ind.com

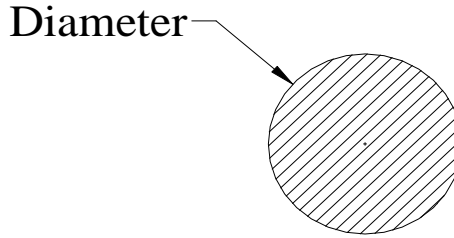

**ROUND
RODS**

No.	Die Number	Diameter			Wt/Ft	Perimeter	Special Notes
1	AF-2573	0.250			0.059	0.785	
2	AF-5338	0.307			0.089	0.964	
3	AF-2317	0.312			0.092	0.980	
4	AF-1204	0.375			0.133	1.178	
5	AF-0778	0.500			0.235	1.570	
6	AF-0817	0.750			0.519	2.350	
7	AF-3822	0.994			0.932	3.123	
8	AF-0818	1.000			0.923	3.142	
9	AF-3781	1.498			2.326	4.706	
10	AF-3371	1.500			2.121	4.712	
11	AF-3496	2.000			3.770	6.283	
12							
13							
14							
15							
16							
17							
18							
19							
20							
21							
22							
23							
24							
25							
26							
27							
28							
29							
30							
31							
32							
33							
34							
35							
36							
37							
38							
39							
40							



3400 Roy Street
 P.O. Box 5085
 Alexandria, LA 70302
 Phone: 800.551.6576
 Fax: 318.443.9288
 www.afco-ind.com

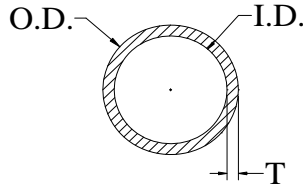

ROUND TUBES

No.	Die Number	O.D.	I.D.	T			Wt/Ft	Perimeter	Special Notes
1	AF-2234	0.375	0.295	0.040			0.062	1.178	
2	AF-1635	0.500	0.400	0.050			0.085	1.571	
3	AF-1095	0.625	0.395	0.115			0.221	1.963	
4	AF-2818	0.625	0.501	0.062			0.136	1.963	
5	AF-0875	0.625	0.527	0.049			0.107	1.963	
6	AF-4695	0.750	0.300	0.225			0.445	2.356	
7	AF-3336	0.750	0.500	0.250			0.325	2.356	
8	AF-1470	0.750	0.626	0.062			0.162	2.356	
9	AF-2984	0.750	0.656	0.047			0.125	2.356	
10	AF-2338	0.810	0.565	0.123			0.327	2.545	
11	AF-2985	0.812	0.688	0.062			0.181	2.551	
12	AF-3502	0.875	0.761	0.057			0.175	2.749	
13	AF-1415	0.875	0.795	0.040			0.124	2.748	
14	AF-0751	0.880	0.777	0.051			0.159	2.765	
15	AF-0797	0.882	0.777	0.054			0.170	2.780	
16	AF-0777	0.885	0.635	0.125			0.358	2.780	
17	AF-0739	1.000	0.625	0.187			0.574	3.142	
18	AF-0740	1.000	0.750	0.125			0.412	3.142	
19	AF-3533	1.000	0.820	0.090			0.308	3.142	
20	AF-3372	1.000	0.844	0.078			0.271	3.142	
21	AF-2086	1.000	0.870	0.065			0.236	3.142	
22	AF-3418	1.000	0.876	0.062			0.219	3.142	
23	AF-1484	1.000	0.920	0.040			0.143	3.142	
24	AF-4381	1.250	1.050	0.100			0.433	3.927	
25	AF-4202	1.250	1.090	0.080			0.353	3.927	
26	AF-3183	1.250	1.126	0.062			0.286	3.927	
27	AF-2707	1.250	1.150	0.050			0.233	3.927	
28	AF-2901	1.250	1.150	0.050			0.233	3.927	
29	AF-2492	1.375	1.125	0.125			0.607	4.320	
30	AF-1487	1.375	1.250	0.062			0.305	4.320	
31	AF-4545	1.405	0.995	0.205			0.926	4.414	
32	AF-2423	1.435	1.025	0.205			0.979	4.508	
33	AF-2502	1.475	1.025	0.225			1.092	4.634	
34	AF-2796	1.490	1.050	0.220			1.085	4.681	
35	AF-3934	1.500	1.246	0.127			0.655	4.712	
36	AF-4469	1.500	1.250	0.125			0.648	4.712	
37	AF-0522	1.500	1.376	0.062			0.336	4.712	
38	AF-2114	1.670	1.270	0.200			1.141	5.426	
39	AF-5039	1.750	0.400	0.675			2.735	6.755	ADA SPACER
40	AF-3451	1.770	1.490	0.140			0.861	5.561	
41	AF-3772	1.900	1.682	0.109			0.736	5.969	
42	AF-2546	1.968	1.550	0.209			1.386	6.183	
43	AF-3460	2.000	1.700	0.150			1.046	6.283	
44	AF-1287	2.000	1.870	0.065			0.475	6.283	
45	AF-1628	2.000	1.876	0.062			0.453	6.283	



3400 Roy Street
 P.O. Box 5085
 Alexandria, LA 70302
 Phone: 800.551.6576
 Fax: 318.443.9288
 www.afco-ind.com

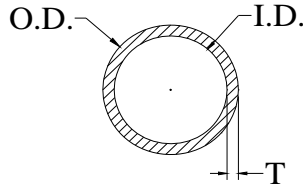

ROUND TUBES

No.	Die Number	O.D.	I.D.	T			Wt/Ft	Perimeter	Special Notes
46	AF-3565	2.035	1.795	0.120			0.866	6.393	
47	AF-4450	2.100	1.800	0.060			1.103	6.597	
48	AF-4220	2.100	2.175	0.112			0.971	7.540	
49	AF-3760	2.140	1.900	0.120			0.915	6.723	
50	AF-3001	2.375	0.875	0.750			4.733	7.461	
51	AF-3573	2.375	1.939	0.218			1.772	7.461	
52	AF-3905	2.375	2.210	0.083			0.706	7.461	
53	AF-1128	2.375	2.215	0.080			0.692	7.461	
54	AF-1247	2.381	2.151	0.115			0.983	7.480	
55	AF-1129	2.500	2.254	0.123			1.103	7.854	
56	AF-2132	2.500	2.360	0.070			0.660	7.854	
57	AF-3973	2.782	2.532	0.125			1.253	8.740	
58	AF-3761	2.875	2.535	0.170			1.734	9.032	
59	AF-4171	2.875	2.660	0.105			1.122	9.032	
60	AF-3904	3.125	2.661	0.232			2.531	9.818	
61	AF-4434	3.375	3.187	0.094			1.163	10.603	
62									
63									
64									
65									
66									
67									
68									
69									
70									
71									
72									
73									
74									
75									
76									
77									
78									
79									
80									
81									
82									
83									
84									
85									
86									
87									
88									
89									
90									



3400 Roy Street
 P.O. Box 5085
 Alexandria, LA 70302
 Phone: 800.551.6576
 Fax: 318.443.9288
 www.afco-ind.com

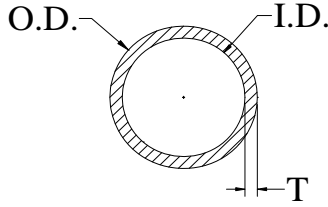

**SCHEDULE
 PIPE**

No.	Die Number	Pipe Size	O.D.	I.D.	T	Wt/Ft	Perimeter	Special Notes
1	AF-1394	1" S/40	1.315	1.049	0.133	0.593	4.131	
2	AF-0827	1 1/4" S/10	1.660	1.442	0.109	0.638	5.215	
3	AF-3911	1 1/2" S/80	1.900	1.500	0.200	1.282	5.969	
4	AF-0488	1 1/2" S/40	1.900	1.610	0.145	0.959	5.969	
5	AF-0627	1 1/2" S/10	1.900	1.682	0.109	0.736	5.969	
6	AF-2830	2" S40	2.375	2.067	0.154	1.289	7.461	
7	AF-3067	2 1/2" S/40	2.875	2.469	0.203	2.045	9.032	
8	AF-4759	3" S/80	3.500	2.900	0.300	3.619	10.996	
9	AF-4602	4" S/40	4.500	4.026	0.237	3.809	14.137	
10								
11								
12								
13								
14								
15								
16								
17								
18								
19								
20								
21								
22								
23								
24								
25								
26								
27								
28								
29								
30								
31								
32								
33								
34								
35								
36								
37								
38								
39								
40								



3400 Roy Street
 P.O. Box 5085
 Alexandria, LA 70302
 Phone: 800.551.6576
 Fax: 318.443.9288
 www.afco-ind.com

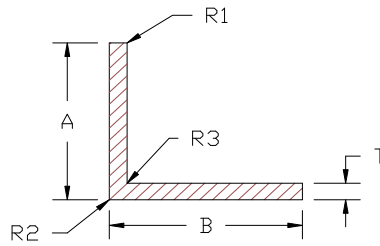

ARCHITECTURAL ANGLES

No.	Die Number	A	B	T	R1	R2	R3	Wt/Ft	Perimeter	Special Notes
1	AF-4003	0.375	1.500	0.063	0.015	0.015	0.015	0.137	3.711	
2	AF-2054	0.500	0.500	0.050	0.010	0.010	0.010	0.058	2.000	
3	AF-1994	0.500	0.500	0.050	0.025	0.010	0.010	0.056	2.000	
4	AF-0040	0.500	0.500	0.062	0.010	0.010	0.010	0.070	2.000	
5	AF-0639	0.500	0.750	0.062	0.010	0.010	0.010	0.089	2.474	
6	AF-4897	0.500	1.000	0.062	0.010	0.010	0.010	0.107	2.986	
7	AF-2485	0.500	1.500	0.125	0.010	0.010	0.010	0.281	4.000	
8	AF-3327	0.500	1.844	0.063	0.025	0.050	0.030	0.176	4.611	
9	AF-2545	0.618	0.743	0.050	0.010	0.010	0.010	0.081	2.734	
10	AF-0916	0.625	1.000	0.050	0.010	0.010	0.010	0.095	3.250	
11	AF-4613	0.625	1.000	0.125	0.010	0.010	0.010	0.224	3.236	
12	AF-2440	0.687	0.400	0.040	0.010	0.010	0.010	0.052	2.174	
13	AF-2055	0.750	0.750	0.050	SC	SC	SC	0.087	3.000	
14	AF-0041	0.750	0.750	0.062	SC	SC	SC	0.107	3.000	
15	AF-0186	0.750	0.750	0.125	0.015	0.015	0.015	0.206	2.961	
16	AF-1829	0.750	1.000	0.125	SC	SC	SC	0.244	3.500	
17	AF-4432	0.750	1.250	0.062	0.010	0.010	0.010	0.144	4.000	
18	AF-3426	0.750	3.000	0.125	0.010	0.010	0.010	0.598	7.474	
19	AF-3078	0.875	0.375	0.050	0.010	0.010	0.010	0.074	2.500	
20	AF-0481	0.875	0.875	0.062	0.010	0.010	0.010	0.126	3.474	
21	AF-1764	0.918	0.918	0.125	SC	SC	SC	0.259	3.672	
22	AF-3765	0.938	0.938	0.046	0.010	0.010	0.010	0.101	3.752	
23	AF-3770	0.938	1.500	0.050	0.010	0.010	0.010	0.143	4.876	
24	AF-1654	1.000	1.000	0.050	0.015	0.015	0.015	0.117	4.000	
25	AF-0042	1.000	1.000	0.062	0.010	0.010	0.010	0.144	4.000	
26	AF-3090	1.000	1.000	0.062	F.R.	0.015	0.015	0.143	3.968	
27	AF-0185	1.000	1.000	0.125	0.010	0.010	0.010	0.281	4.000	
28	AF-2117	1.000	1.500	0.062	0.010	0.010	0.010	0.187	5.150	
29	AF-0256	1.000	1.500	0.125	0.015	0.015	0.015	0.356	4.961	
30	AF-3672	1.000	1.500	0.187	0.010	0.010	0.010	0.520	5.000	
31	AF-1347	1.000	2.000	0.050	0.010	0.010	0.010	0.176	5.974	
32	AF-2522	1.000	2.000	0.100	0.010	0.031	0.010	0.358	5.987	
33	AF-3817	1.000	2.000	0.188	0.010	0.010	0.010	0.635	6.000	
34	AF-4701	1.000	3.000	0.100	F.R.	0.375	0.275	0.449	7.647	
35	AF-1266	1.000	3.000	0.125	0.010	0.010	0.010	0.581	7.974	
36	AF-3818	1.000	3.000	0.188	0.010	0.010	0.010	0.861	8.000	
37	AF-4642	1.250	1.250	0.050	0.010	0.010	0.010	0.146	4.986	
38	AF-1168	1.250	1.250	0.125	0.010	0.010	0.010	0.356	4.974	
39	AF-3112	1.250	1.250	0.250	0.010	0.010	0.010	0.695	5.000	
40	AF-3767	1.500	1.500	0.050	0.010	0.010	0.010	0.176	6.062	
41	AF-0351	1.500	1.500	0.062	0.015	0.015	0.015	0.218	5.961	
42	AF-0167	1.500	1.500	0.125	0.010	0.010	0.010	0.431	6.000	
43	AF-4656	1.500	1.750	0.060	0.015	0.015	0.015	0.229	6.461	

*SC = Sharp Corners, F.R. = Full Radius



3400 Roy Street
 P.O. Box 5085
 Alexandria, LA 70302
 Phone: 800.551.6576
 Fax: 318.443.9288
 www.afco-ind.com

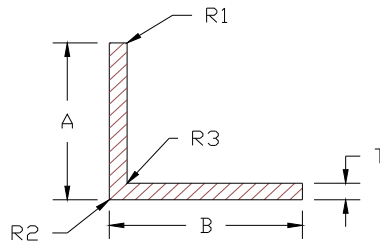

ARCHITECTURAL ANGLES

No.	Die Number	A	B	T	R1	R2	R3	Wt/Ft	Perimeter	Special Notes
44	AF-3674	1.500	2.000	0.187	0.010	0.010	0.010	0.744	7.000	
45	AF-4647	1.500	2.000	0.250	0.010	0.010	0.010	0.974	6.974	
46	AF-3673	1.500	2.500	0.250	0.010	0.010	0.010	1.126	8.000	
47	AF-2593	1.750	1.750	0.125	SC	SC	SC	0.521	7.000	
48	AF-2700	2.000	2.000	0.063	0.010	0.010	0.010	0.304	8.000	
49	AF-4230	2.000	2.000	0.105	0.010	0.010	0.010	0.491	8.000	
50	AF-1206	2.000	2.000	0.125	0.010	0.010	0.010	0.581	7.974	
51	AF-0234	2.000	2.000	0.250	0.015	0.015	0.015	1.124	7.961	
52	AF-3828	3.000	3.000	0.125	0.010	0.010	0.010	0.881	12.000	
53	AF-4751	3.000	5.000	0.085	0.010	0.010	0.010	0.808	15.986	
54	AF-2572	4.000	4.000	0.250	SC	SC	SC	2.395	16.000	
55										
56										
57										
58										
59										
60										
61										
62										
63										
64										
65										
66										
67										
68										
69										
70										
71										
72										
73										
74										
75										
76										
77										
78										
79										

*SC = Sharp Corners, F.R. = Full Radius



3400 Roy Street
 P.O. Box 5085
 Alexandria, LA 70302
 Phone: 800.551.6576
 Fax: 318.443.9288
 www.afco-ind.com

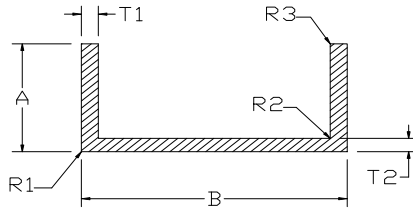

ARCHITECTURAL CHANNELS

No.	Die Number	A	B	T1	T2	R1	R2	R3	Wt/Ft	Perimeter	Special Notes
1	AF-2271	0.140	1.344	0.045	0.045	SC	SC	FR	0.085	3.158	
2	AF-3450	0.375	0.750	0.094	0.094	SC	SC	SC	0.152	2.812	
3	AF-2145	0.438	0.375	0.063	0.063	SC	SC	SC	0.087	2.375	
4	AF-3449	0.500	0.313	0.045	0.045	SC	SC	SC	0.068	2.535	
5	AF-2528	0.500	0.422	0.062	0.062	0.010	0.010	0.010	0.097	2.719	
6	AF-1022	0.500	0.500	0.062	0.062	0.010	0.010	0.010	0.102	2.842	
7	AF-4407	0.500	0.550	0.062	0.062	SC	SC	SC	0.106	2.949	
8	AF-2530	0.500	0.641	0.062	0.062	SC	SC	SC	0.113	3.157	
9	AF-1544	0.500	1.000	0.062	0.062	0.010	0.010	0.010	0.140	3.842	
10	AF-1521	0.500	1.000	0.125	0.125	0.015	0.015	0.015	0.263	3.750	
11	AF-3381	0.600	1.740	0.105	0.105	0.030	0.010	0.010	0.353	5.644	
12	AF-3392	0.600	3.485	0.105	0.105	0.030	SC	SC	0.469	9.134	
13	AF-2531	0.625	0.891	0.062	0.062	SC	SC	SC	0.150	4.157	
14	AF-4084	0.625	4.175	0.090	0.090	0.025	SC	0.015	0.566	10.614	
15	AF-4125	0.625	5.080	0.100	0.090	0.025	SC	0.015	0.677	12.424	
16	AF-4085	0.625	6.190	0.090	0.090	0.025	SC	0.015	0.825	14.644	
17	AF-2734	0.665	2.050	0.040	0.040	SC	SC	SC	0.158	6.680	
18	AF-1371	0.750	0.450	0.037	0.037	0.010	0.010	F.R.	0.083	3.747	
19	AF-3480	0.750	0.500	0.094	0.094	0.010	0.010	0.010	0.210	3.794	
20	AF-1911	0.750	0.600	0.037	0.037	SC	SC	SC	0.093	4.126	
21	AF-2514	0.750	0.750	0.062	0.062	0.010	0.010	0.010	0.159	4.375	
22	AF-2359	0.750	0.813	0.062	0.062	SC	SC	SC	0.160	4.051	
23	AF-0741	0.750	0.875	0.037	0.037	0.070	0.031	0.010	0.100	4.572	
24	AF-1449	0.750	0.875	0.037	0.037	0.070	0.031	0.010	0.102	4.580	
25	AF-3338	0.750	1.075	0.037	0.037	0.070	0.031	0.010	0.113	4.848	
26	AF-0774	0.750	1.875	0.037	0.037	0.070	0.031	0.010	0.144	6.572	
27	AF-4731	0.750	1.895	0.250	0.187	0.010	0.010	0.010	0.763	6.381	
28	AF-4754	0.750	3.000	0.125	0.125	0.010	0.031	0.031	0.636	8.661	
29	AF-4872	0.750	4.000	0.125	0.125	0.031	0.010	0.031	0.787	10.716	
30	AF-2733	0.790	1.580	0.040	0.040	0.031	0.010	F.R.	0.145	6.108	
31	AF-3070	0.800	4.500	0.100	0.100	0.010	0.010	0.010	0.729	12.000	
32	AF-4165	0.850	1.140	0.080	0.125	0.030	SC	0.030	0.309	5.353	
33	AF-0987	0.875	0.796	0.045	0.045	0.010	0.010	0.010	0.133	5.000	
34	AF-0216	0.875	1.125	0.062	0.062	0.015	0.015	0.015	0.206	5.574	
35	AF-3993	0.875	1.920	0.190	0.120	0.060	0.190	0.010	0.638	6.885	
36	AF-4074	1.000	0.376	0.063	0.063	0.010	0.010	0.010	0.171	4.626	
37	AF-4076	1.000	0.438	0.063	0.063	0.010	0.010	0.010	0.176	4.750	
38	AF-1112	1.000	1.000	0.125	0.125	0.010	0.010	0.010	0.413	4.000	
39	AF-4641	1.000	1.175	0.375	0.375	0.010	0.010	0.010	1.091	5.566	
40	AF-4595	1.000	1.184	0.092	0.092	0.010	0.010	0.010	0.331	6.150	
41	AF-4566	1.000	1.710	0.105	0.105	0.015	0.015	0.015	0.441	7.158	
42	AF-0815	1.000	1.952	0.250	0.250	0.062	0.031	0.031	1.036	7.244	
43	AF-3969	1.000	2.000	0.063	0.063	0.010	0.010	0.010	0.293	7.874	

*SC = Sharp Corners

*FR = Full Radius

AFCO Industries, Inc.



3400 Roy Street
 P.O. Box 5085
 Alexandria, LA 70302
 Phone: 800.551.6576
 Fax: 318.443.9288
 www.afco-ind.com

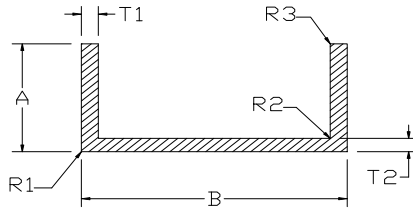

STANDARD SHAPES

ARCHITECTURAL CHANNELS

No.	Die Number	A	B	T1	T2	R1	R2	R3	Wt/Ft	Perimeter	Special Notes
44	AF-2641	1.000	2.000	0.125	0.125	SC	SC	SC	0.620	7.770	
45	AF-3547	1.000	2.000	0.200	0.200	0.300	0.100	0.100	0.919	8.257	
46	AF-4290	1.000	2.184	0.092	0.092	0.010	0.010	0.010	0.442	8.184	
47	AF-1130	1.000	3.000	0.125	0.125	0.010	0.010	0.010	0.713	9.516	
48	AF-3044	1.000	4.000	0.688	0.188	SC	SC	SC	2.308	11.625	
49	AF-4294	1.000	6.184	0.092	0.092	0.010	0.010	0.010	0.883	16.184	
50	AF3525	1.125	3.245	0.125	0.125	0.010	0.010	F.R.	0.783	10.633	
51	AF-4569	1.125	3.660	0.125	0.125	0.010	0.010	F.R.	0.845	11.466	
52	AF-3538	1.350	0.906	0.055	0.055	0.027	SC	F.R.	0.230	7.032	
53	AF-3321	1.375	3.200	0.100	0.100	0.030	0.030	0.030	0.690	11.648	
54	AF-2337	1.375	5.406	0.188	0.188	0.312	0.125	F.R.	1.755	15.400	
55	AF-2486	1.500	0.500	0.062	0.062	SC	SC	SC	0.279	7.266	
56	AF-3763	1.500	1.000	0.063	0.063	0.008	0.008	0.008	0.293	7.874	
57	AF-4649	1.500	1.905	0.187	0.187	0.093	0.063	F.R.	1.006	9.142	
58	AF-3550	1.500	2.500	0.610	0.375	SC	SC	SC	2.855	10.250	
59	AF-4567	1.500	3.375	0.125	0.125	0.010	0.010	0.010	0.919	12.466	
60	AF-3323	1.625	4.250	0.125	0.125	0.030	0.030	0.030	1.086	14.647	
61	AF-4580	1.750	6.198	0.083	0.083	0.015	0.015	0.015	0.954	19.178	
62	AF-5058	2.000	2.000	0.125	0.125	0.010	0.010	0.010	0.863	11.716	
63	AF-4292	2.000	2.210	0.105	0.105	0.015	0.015	0.015	0.756	12.158	
64	AF-4293	2.000	4.210	0.105	0.105	0.012	0.012	0.012	1.008	16.210	
65	AF-2967	2.250	3.000	0.250	0.250	0.010	0.010	0.010	2.184	14.328	
66	AF-3505	2.500	1.500	0.438	0.438	0.010	0.010	0.010	3.044	12.090	
67	AF-2750	2.500	2.625	0.188	0.188	SC	SC	SC	1.684	14.874	
68	AF-4317	3.000	1.312	0.125	0.125	0.016	0.016	0.016	1.059	14.327	
69											
70											
71											
72											
73											
74											
75											
76											
77											
78											
79											
80											
81											
82											
83											
84											

*SC = Sharp Corners
 *FR = Full Radius



3400 Roy Street
 P.O. Box 5085
 Alexandria, LA 70302
 Phone: 800.551.6576
 Fax: 318.443.9288
 www.afco-ind.com

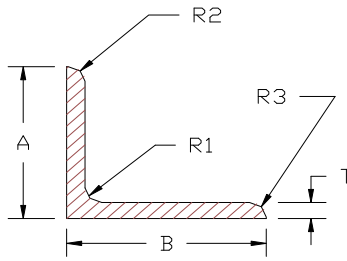

STRUCTURAL ANGLES

No.	Die Number	A	B	T	R1	R2	R3	Wt/Ft	Perimeter	Special Notes
1	AF-0653	0.625	0.625	0.062	0.010	F.R.	F.R.	0.088	2.438	
2	AF-2136	3.000	3.000	0.188	0.187	0.187	0.187	1.454	12.759	
3										
4										
5										
6										
7										
8										
9										
10										
11										
12										
13										
14										
15										
16										
17										
18										
19										
20										
21										
22										
23										
24										
25										
26										
27										
28										
29										
30										
31										
32										
33										
34										
35										
36										
37										
38										
39										
40										
41										
42										



3400 Roy Street
 P.O. Box 5085
 Alexandria, LA 70302
 Phone: 800.551.6576
 Fax: 318.443.9288
 www.afco-ind.com

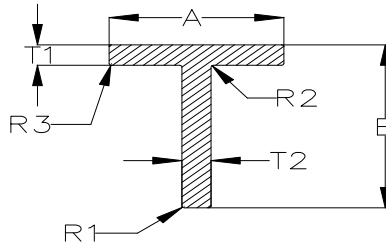

T-SECTIONS

No.	Die Number	A	B	T1	T2	R1	R2	R3	Wt/Ft	Perimeter	Special Notes
1	AF-2747	0.200	1.130	0.060	0.060	0.010	0.010	0.010	0.091	2.637	
2	AF-2494	0.300	1.500	0.060	0.040	SC	SC	SC	0.091	3.600	
3	AF-1712	0.937	0.425	0.050	0.050	0.010	0.010	0.010	0.079	2.724	Offset "T"
4	AF-2655	1.125	0.750	0.125	0.125	0.050	0.050	SC	0.270	3.789	
5	AF-1501	1.250	0.875	0.093	0.093	0.010	0.010	0.010	0.226	3.050	
6	AF-4800	1.500	1.500	0.125	0.125	0.010	0.010	0.010	0.431	5.977	
7	AF-4605	2.000	1.000	0.080	0.080	0.010	0.010	0.010	0.280	5.977	
8	AF-4496	3.000	1.250	0.125	0.125	0.010	0.010	0.010	0.618	8.475	
9	AF-3789	3.500	1.500	0.125	0.125	0.010	0.125	0.010	0.740	9.867	Offset "T"
10											
11											
12											
13											
14											
15											
16											
17											
18											
19											
20											
21											
22											
23											
24											
25											
26											
27											
28											
29											
30											
31											
32											
33											
34											
35											
36											
37											
38											
39											
40											
41											
42											



3400 Roy Street
 P.O. Box 5085
 Alexandria, LA 70302
 Phone: 800.551.6576
 Fax: 318.443.9288
 www.afco-ind.com

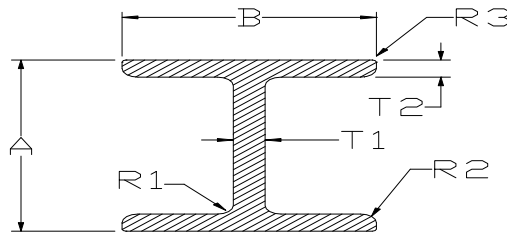

H & I-BEAM

No.	Die Number	A	B	R1	R2	R3	T1	T2	Wt/Ft	Perimeter	Notes
1	AF-4201	1.125	2.125	0.010	0.010	0.010	0.125	0.125	0.793	10.500	
2	AF-4556	1.210	0.925	0.010	0.010	0.010	0.125	0.115	0.402	5.835	
3	AF-4001	1.250	0.814	0.015	0.015	0.015	0.063	0.063	0.208	5.553	
4	AF-3033	3.062	2.750	0.250	SC	SC	0.250	0.250	2.557	16.195	
5	AF-4537	3.650	3.650	0.250	0.030	0.200	0.250	0.250	3.157	20.576	
6	AF-4638	2.000	0.723	0.010	0.031	0.031	0.347	0.473	1.256	6.096	
7											
8											
9											
10											
11											
12											
13											
14											
15											
16											
17											
18											
19											
20											
21											
22											
23											
24											
25											
26											
27											
28											
29											
30											
31											
32											
33											
34											
35											
36											
37											
38											
39											
40											
41											
42											
43											
44											



3400 Roy Street
 P.O. Box 5085
 Alexandria, LA 70302
 Phone: 800.551.6576
 Fax: 318.443.9288
 www.afco-ind.com

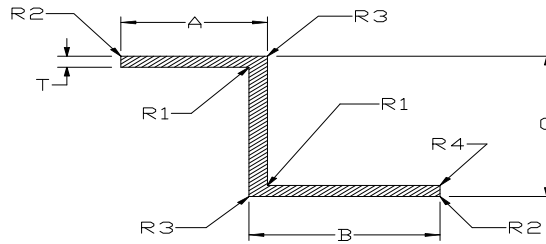

Z-BARS

No.	Die Number	A	B	C	T	R1	R2	R3	R4	Wt/Ft	Perimeter	Special Notes
1	AF-0799	0.590	0.625	0.325	Notes	0.065	0.065	0.015	0.065	0.120	2.766	.070 & .090 Wall Thickness
2	AF-2510	0.750	1.050	0.550	0.050	0.010	0.010	0.010	0.010	0.139	4.600	
3	AF-1435	0.970	1.500	1.327	0.067	0.010	0.010	0.010	0.010	0.336	7.406	
4	AF-3715	1.000	1.000	1.100	0.100	0.025	0.050	0.162	0.050	0.343	5.722	
5												
6												
7												
8												
9												
10												
11												
12												
13												
14												
15												
16												
17												
18												
19												
20												
21												
22												
23												
24												
25												
26												
27												
28												
29												
30												
31												
32												
33												
34												
35												
36												
37												
38												
39												
40												
41												
42												
43												



AFCO Industries, Inc.
 Aluminum Products Division
 3400 Roy Street - P.O. Box 5085
 Alexandria, LA 71302

Phone: 800-551-6576 ** Fax 318-443-9288
 www.afco-ind.com

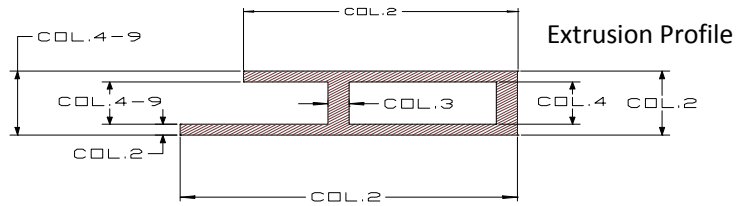

**CROSS-SECTIONAL DIMENSION TOLERANCES
 ALUMINUM ROD, BAR, SHAPES**

Based on Aluminum Association Standard Tolerances 2009, Table 11.2

Specified Dimension (Inches)	TOLERANCE IN PLUS AND MINUS								
	METAL DIMENSIONS		SPACE DIMENSIONS						
	Wall Thickness Metal to Metal	Wall Thickness Of Hollow Profiles	Open gap specified from .250" to .624"	Open gap specified from .625" to 1.249"	Open gap specified from 1.250" to 2.499"	Open gap specified from 2.500" to 3.999"	Open gap specified from 4.000" to 5.999"	Open gap specified from 6.000" to 8.000"	
Depth (Inches)	COL. 2	COL. 3	COL. 4	COL. 5	COL. 6	COL. 7	COL. 8	COL. 9	
Width (Inches)	.000-.124	.006	+/-10% of Specified Dimension; +/- .060 Max. +/- .010 Min.	.010	.012	----	----	----	----
	.125-.249	.007		.012	.014	.016	----	----	----
	.250-.499	.008		.014	.016	.018	.020	----	----
	.500-.749	.009		.016	.018	.020	.022	----	----
	.750-.999	.010		.018	.020	.022	.025	.030	----
	1.000-1.499	.012		.021	.023	.026	.030	.035	----
	1.500-1.999	.014		.024	.026	.031	.036	.042	.050
	2.000-3.999	.024		.034	.038	.048	.057	.068	.080
	4.000-5.999	.034		.044	.050	.064	.078	.094	.110
	6.000-7.999	.044		.054	.062	.082	.099	.120	.140
8.000-9.999	.054	.064	.074	.100	.120	.145	.170		

Notes:

- (1) These Standard Tolerances are applicable to the average profile; wider tolerances may be required for some profiles and closer tolerances may be possible for others.
- (2) At Point less than 0.250 inch from base of leg the tolerances in Col. 2 are applicable.
- (3) This table applies ONLY for Aluminum Alloy: 6005, 6060, 6061, and 6063.
- (4) Use "Aluminum Standard & Data 2009" book for any further questions.

ANGULARITY : Tolerance Degrees plus and minus

ALLOWABLE DEVIATION FROM SPECIFIED ANGLE

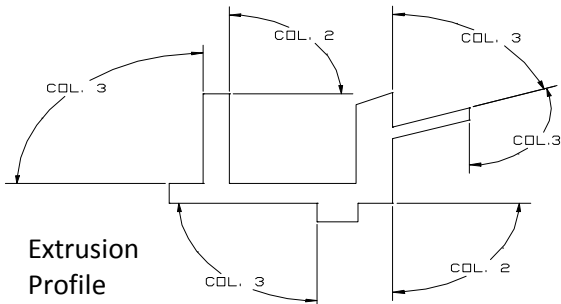

Notes:

- (1) These Standard Tolerances are applicable to the average profile (shape); wider tolerances may be required for some profiles (shapes), and closer tolerances may be possible for others.
- (2) Conditions include die lines and handling marks.
- (3) When two legs are involved the one having the larger ratio determines the applicable column.

Based on Aluminum Association Standard Tolerances, Table 11.14,

Wall thickness (Inch.)	RATIO: LEG OR SURFACE LENGTH TO LEG OR METAL THICKNESS	
	(1) AND LESS	OVER 1 THRU 40
	COL. 2	COL. 3
UP THRU .187	1 Degree	2 Degrees
0.188 TO 0.749	1 Degree	1.5 Degrees
0.750 AND OVER	1 Degree	1 Degree



AFCO INDUSTRIES, INC.

Aluminum Products
 P.O. BOX 5085 * 3400 ROY STREET
 ALEXANDRIA, LA. 71302
 Phone: 318-448-1651
 FAX : 318-443-9288
 www.afco-ind.com

UNCONTROLLED COPY
 FOR REFERENCE ONLY

STRAIGHTNESS, TWIST, FLATNESS, CORNERS RADII TOLERANCES & PRODUCT DESIGN GUIDE

Table 1. STRAIGHTNESS – ROD, BAR, AND PROFILES

ALLOWABLE DEVIATION (D)
 FROM STRAIGHT:
 IN TOTAL LENGTH OR IN ANY
 MEASURED SEGMENT OF ONE
 FT. OR MORE OF TOTAL
 LENGTH, THE TOLERANCE
 SHALL BE .012" PER FOOT
 UNLESS OTHERWISE SPECIFIED.

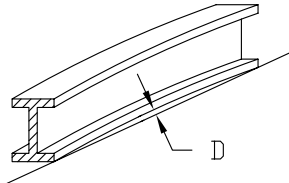
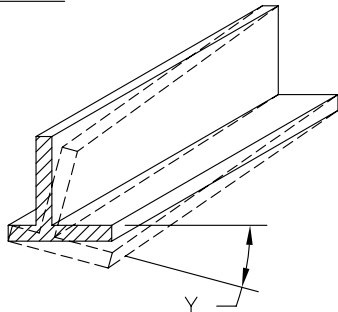

Table 2. TWIST – BAR AND PROFILES

ALLOWABLE DEVIATION
 FROM STRAIGHT



UNLESS OTHERWISE SPECIFIED THE FOLLOWING
 TOLERANCES SHALL BE APPLIED:

Specified Width (BAR)	In total length or in any measured segment of one Ft. or more of total length	Maximum for total length
Up thru 1.499	1° x Measured Length, ft.	7
1.500 – 2.999	1/2° x Measured Length, ft.	5
3.000 and over	1/4° x Measured Length, ft.	3

Table 3. FLATNESS (FLAT SURFACE) – BAR, SOLID PROFILES AND SEMIHOLLOW PROFILES

WIDTHS OVER 1 INCH. MAXIMUM
 ALLOWABLE DEVIATION D =
 TOLERANCE x WIDTH (In.)
 THE TOLERANCE SHALL BE .004" PER
 INCH OF THE WIDTH
 UNLESS OTHERWISE SPECIFIED.

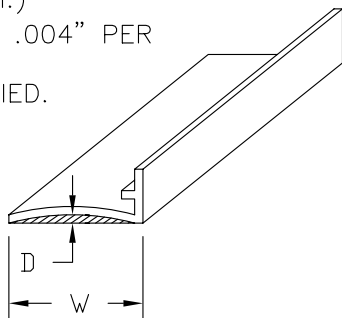
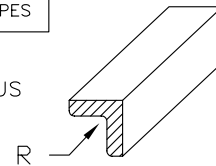

Table 4. CORNER & FILLET RADII FOR BARS AND SHAPES

TOLERANCE – INCH OR PERCENT
 ALLOWABLE DEVIATION FROM SPECIFIED RADIUS
 1. SHARP CORNERS: ±0.016
 2. CORNERS > .188" R: ± 10%



MECHANICAL PROPERTIES:
 EXTRUDED WIRE, ROD, BAR & PROFILES – REFERENCE TABLE

ALLOY TEMPER	THICKNESS (Inches)	Tensile Min. (ksi)	Tensile Max. (ksi)	Yield Min. (ksi)	Yield Max. (ksi)	Elong. % Min. in.
6005A-T1	UP THRU 0.249	25	--	14.5	--	15
6005A-T5	UP THRU 0.249	38	--	31	--	7
	0.250 – 0.999	38	--	31	--	9
6005A-T61	UP THRU 0.249	38	--	35	--	8
	0.250 – 0.999	38	--	35	--	10
6063-T1	UP THRU 0.500	17	--	9	--	12
	0.501 – 1.000	16	--	8	--	12
6063-T4	UP THRU 0.500	19	--	10	--	14
	0.501 – 1.000	18	--	9	--	14
6063-T5	UP THRU 0.500	22	--	16	--	8
	0.501 – 1.000	21	--	15	--	8
6063-T52	UP THRU 1.000	22	30	16	25	8
6063-T6	UP THRU 0.124	30	--	25	--	8
	0.125 – 1.000	30	--	25	--	10

STANDARD EXTRUSION CUT LENGTH TOLERANCES

Specific Diameter (rod), Width (bar), C.C. Diameter* (shape) of Extrusion	TOLERANCE (INCHES: PLUS)	
	ALLOWABLE DEVIATION FROM SPECIFIC LENGTH	
	SPECIFIC LENGTH – FT.	
	UP THRU 12'	OVER 12' THRU 30'
UP THRU 2.999	1/8"	1/4"
3.000 – 7.999	3/16"	5/16"

STANDARD SCREW SLOTS FOR ENGINEERING REFERENCE:

SELF TAPPING SCREW TYPE F		
NC	NF	SLOT DIAMETER
4-40	4-48	0.099 +/- 0.006
6-32	6-40	0.120 +/- 0.006
8-32	8-36	0.147 +/- 0.006
10-24	10-32	0.169 +/- 0.006
12-24	12-28	0.190 +/- 0.006
1/4-20	1/4-28	0.228 +/- 0.006

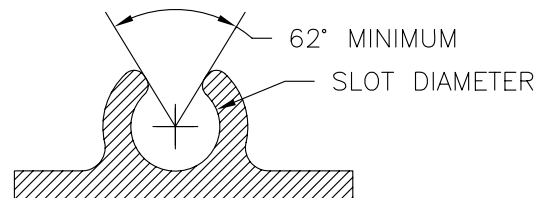

* C.C. Diameter = Circumscribing Circle diameter, the diameter of the smallest circle that will completely enclose the cross section of the extruded product.